

avintage●●●

Built-in range

Single-compartment service wine cabinet

24 bottles*

AVI24PREMIUM

- *Built-in column*
- *Cooling system: compressor (air moving system)*
- *Adjustable temperature range of use: 5°-18°C*
- *Black metal external body*
- *Black PVC inner liner*
- *1 glass door, anti-UV treated, 2-layers tempered glass (grey-colored), black piano organic glass frame*
- *Electronic regulation*
- *3 semi-sliding wooden shelves, metal front*



An Avintage innovation and exclusivity!

- **Push-pull system:** no need for a handle to open and close your door. A slight bit of pressure on the top corner on the left side and it's done!

- Optimization of energy consumption: **A class**



avintage

Reference: AVI24PREMIUM

- **Ambient temperature range of use:**
10°-32°C
- **Equipments included:**
2 adjustable feet (height 2 cm)
White LED lights with ON/OFF switch button
Anti-vibration system
Thermometer with white electronic display
- **Technical characteristics:**
Voltage: 220-240 V
Power input: 85.0 W
Annual electrical consumption: 108.0 kWh
Energy class: A
Climatic class: N-SN
Noise level: 37.0 dB

- **Logistic datas:**

Dimension UVC (W x D x H cm):

Packed: 65 x 65 x 51.5
Unpacked: 59.4 x 55.5 x 45.9

Weight UVC (Kg):

Gross: 32,00
Net: 28,00

Pallet dimensions (cm): /

Full truck (UVC): 180

Container (UVC):

20': 108
40': 216
40' HC: 270

Gencod UVC: 3595320103748

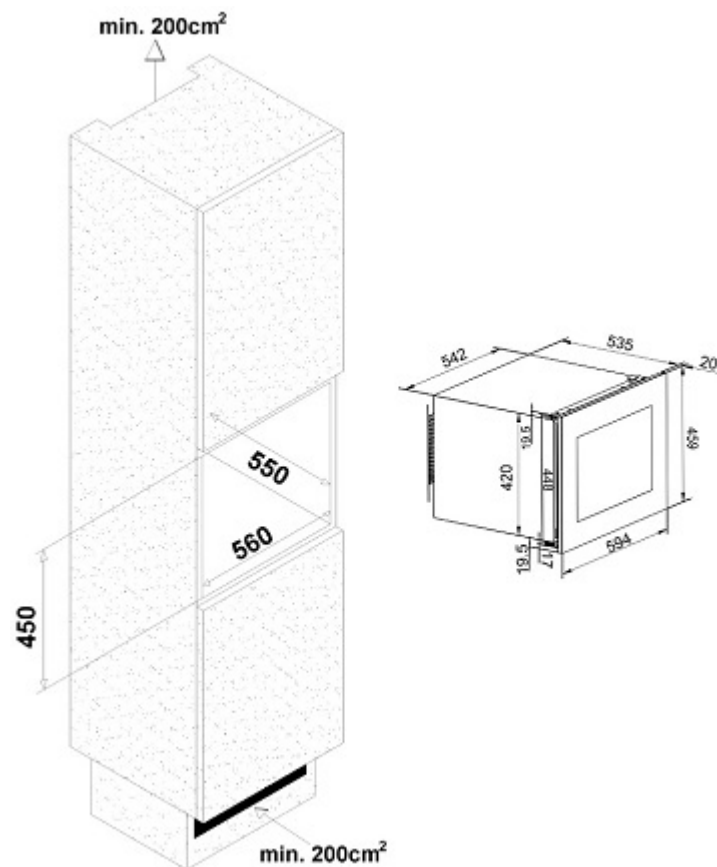

Non-contractual pictures

* Capacity given with 75cl Bordeaux traditional type bottles on 3 shelves. Adding shelves reduce considerably the total capacity.